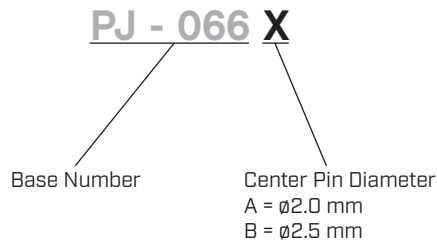

SERIES: PJ-066X | **DESCRIPTION:** DC POWER JACK**FEATURES**

- mounting hardware includes nut and washer
- panel mount
- metal bushing

**PART NUMBER KEY****SPECIFICATIONS**

parameter	conditions/description	min	typ	max	units
rated input voltage			24		Vdc
rated input current				5	A
contact resistance				30	m Ω
insulation resistance	at 500 Vdc	100			M Ω
voltage withstand	for 1 minute			500	Vac
insertion/withdrawl force		0.2		3.0	kgf
operating temperature		-25		70	$^{\circ}$ C
storage temperature		-40		85	$^{\circ}$ C
life			5,000		cycles
RoHS	yes				

SOLDERABILITY

parameter	conditions/description	min	typ	max	units
hand soldering	for 3~5 seconds	295	300	305	$^{\circ}$ C
wave soldering	for 3~5 seconds	245	250	255	$^{\circ}$ C

MECHANICAL DRAWING

units: mm
 tolerance:
 X.X ±0.50 mm
 X.XX ±0.30 mm
 X.XXX ±0.15 mm
 PCB: ±0.05 mm
 unless otherwise specified

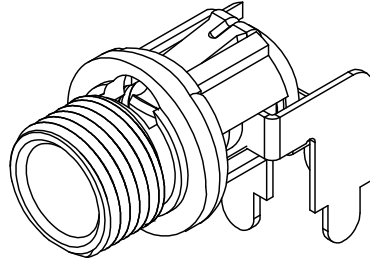

DESCRIPTION	MATERIAL	PLATING/COLOR
center pin	brass	10 μ" min CuSn
terminal 1	brass	8 μ" min silver
terminal 2	phosphor bronze	8 μ" min silver
terminal 3	phosphor bronze	8 μ" min silver
bushing	brass	10 μ" min CuSn
washer 1	bakelite	---
housing	PBT (UL94V-0)	black
nut	brass	40 μ" min nickel
washer 2	brass	40 μ" min nickel

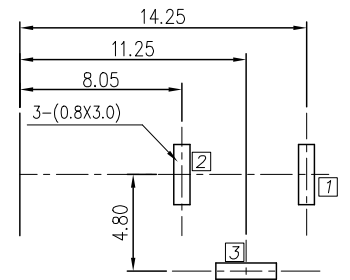
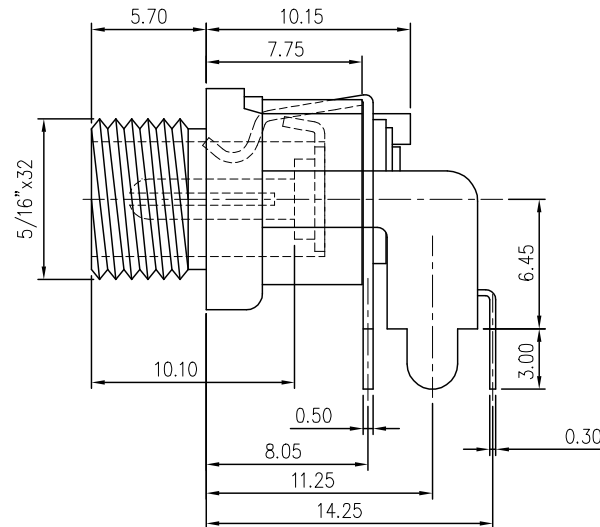
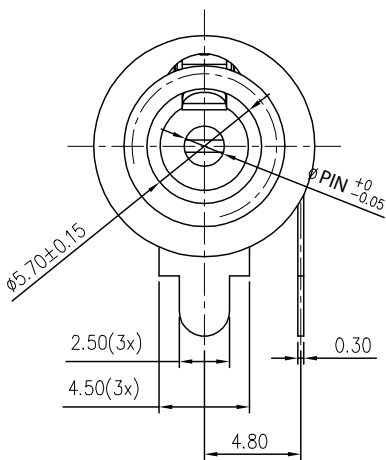
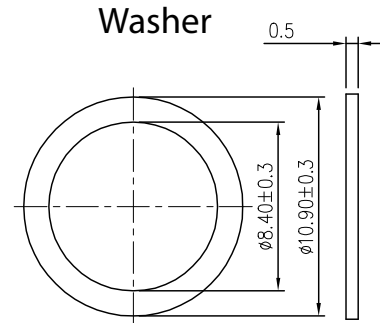
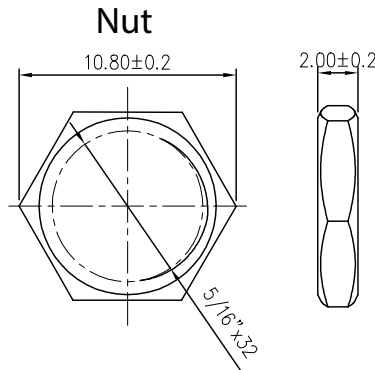
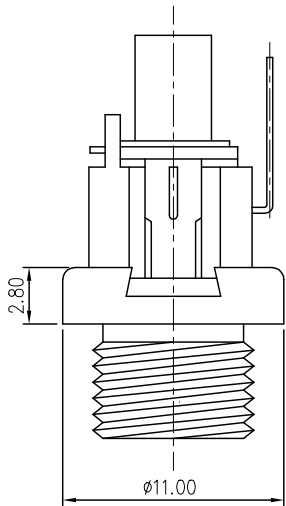

Recommended PCB Layout
Top View

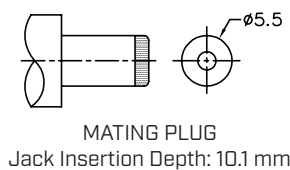

Schematic	
Model	Center Pin
PJ-066A	∅2.0 mm
PJ-066B	∅2.5 mm

REVISION HISTORY

rev.	description	date
1.0	initial release	08/03/2010
1.01	new template applied	06/14/2012
1.02	updated voltage and current rating	12/19/2012
1.03	brand update	10/30/2019
1.04	CUI Devices rebranded to Same Sky	09/12/2024
1.05	factory location change	05/22/2026

The revision history provided is for informational purposes only and is believed to be accurate.



Same Sky offers a one (1) year limited warranty. Complete warranty information is listed on our website.

Same Sky reserves the right to make changes to the product at any time without notice. Information provided by Same Sky is believed to be accurate and reliable. However, no responsibility is assumed by Same Sky for its use, nor for any infringements of patents or other rights of third parties which may result from its use.

Same Sky products are not authorized or warranted for use as critical components in equipment that requires an extremely high level of reliability. A critical component is any component of a life support device or system whose failure to perform can be reasonably expected to cause the failure of the life support device or system, or to affect its safety or effectiveness.

[sameskydevices.com](https://www.sameskydevices.com)