

SERIES: PBM1 | **DESCRIPTION:** PUSH BUTTON SWITCH

FEATURES

- anti-vandal
- stainless steel
- 2 V, 3 V, 5-12 V, 24~36 V LED voltage options
- raised button
- flush button



SPECIFICATIONS

parameter	conditions/description	min	typ	max	units
rated voltage				36 250	Vdc Vac
rated current	Vdc Vac			2.0 6.0	A A
withstanding voltage	for 1 minute		1,500		Vac
contact resistance				50	mΩ
insulation resistance	at 500 Vdc	100			MΩ
operating force		300	450	600	gf
actuator travel		1.0	1.5	2.0	mm
operating temperature		-20		85	°C
life	electrical mechanical		50,000 200,000		cycles cycles
hand soldering	for 3±0.5 seconds	345	350	355	°C
RoHS	yes				
IP level	IP67				

LED SPECIFICATIONS

parameter	conditions/description	min	typ	max	units
forward voltage [Vf]	at If=15 mA				
	red [2 V]	1.8	2.0	2.4	V
	blue [3 V]	2.8	3.0	3.4	V
	green [3 V]	2.8	3.0	3.4	V
	white [3 V]	2.8	3.0	3.4	V
	blue [12 V]	5.0	12	13.0	V
	green [12 V]	5.0	12	13.0	V
	red [12 V]	5.0	12	13.0	V
	white [12 V]	5.0	12	13.0	V
	blue [24 V]: external resistor required	24		36	V
	green [24 V]: external resistor required	24		36	V
	red [24 V]: external resistor required	24		36	V
	white [24 V]: external resistor required	24		36	V

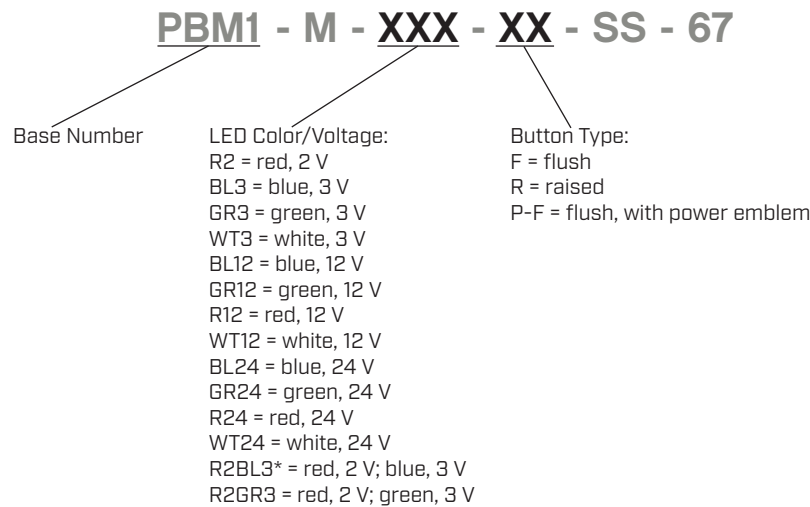
PART NUMBER KEY



Note: *Dual red-blue LED version only available with flush button.

MECHANICAL DRAWING (POWER EMBLEM)

units: mm
 tolerance:
 $X \leq 5.0: \pm 0.2$ mm
 $5.0 < X < 30.0: \pm 0.3$ mm
 $X \geq 30.0: \pm 0.5$ mm
 unless otherwise noted
 panel thickness: 6.0 mm max

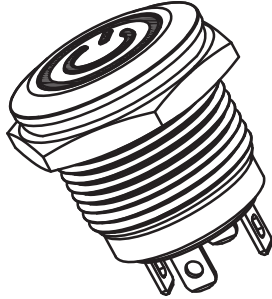

DESCRIPTION	MATERIAL	PLATING/COLOR
housing	stainless steel	---
actuator	stainless steel	---
switch terminals	brass	gold
LED terminals	brass	silver
nut	brass	nickel
base	PA66 (UL94HB)	white

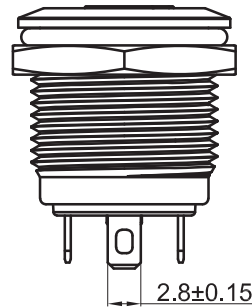
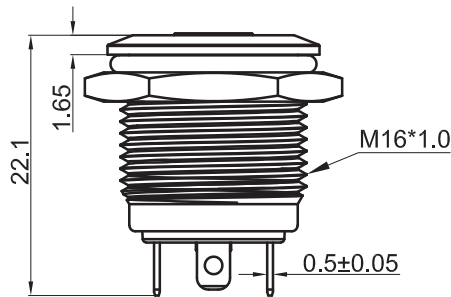
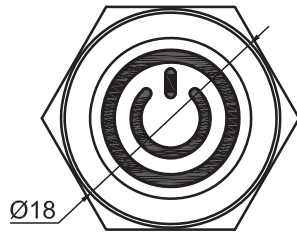

ACTUATOR POSITION (): MOMENTARY	
NORMAL	DOWN
OFF	[ON]
SCHEMATIC	

LED Terminal Pin(Silver plated)

Connector Pin(Gold plated)

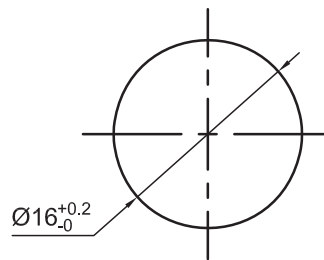
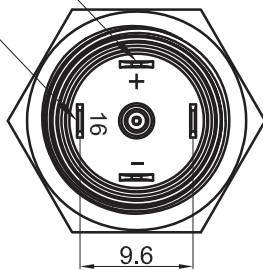

Recommended Panel Cutout

LED Table			
Model	Red-Green Model	2-12 V LED Models	24 V LED Models
Polarity			

MECHANICAL DRAWING (NO POWER EMBLEM)

units: mm
 tolerance:
 $X \leq 5.0$: ± 0.2 mm
 $5.0 < X < 30.0$: ± 0.3 mm
 $X \geq 30.0$: ± 0.5 mm
 unless otherwise noted
 panel thickness: 6.0 mm max

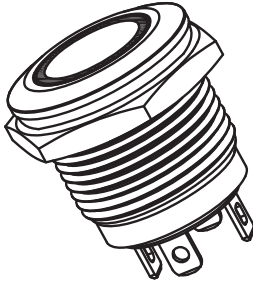

DESCRIPTION	MATERIAL	PLATING/COLOR
housing	stainless steel	---
actuator	stainless steel	---
switch terminals	brass	gold
LED terminals	brass	silver
nut	brass	nickel
base	PA66 (UL94HB)	white

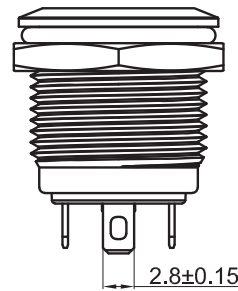
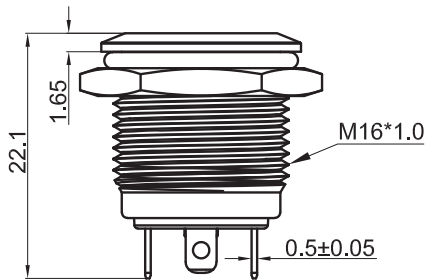
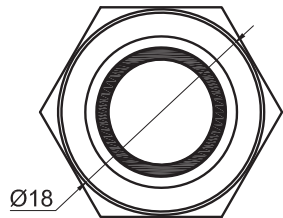

ACTUATOR POSITION (): MOMENTARY	
NORMAL	DOWN
OFF	[ON]
SCHEMATIC	

LED Terminal Pin (Silver plated)

Connector Pin (Gold plated)

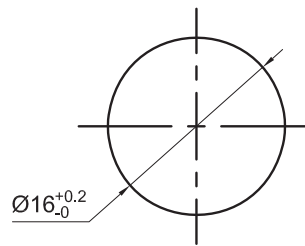
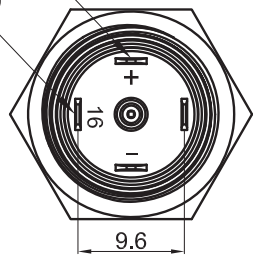

Recommended Panel Cutout

LED Table				
Model	Red-Blue Model	Red-Green Model	2-12 V LED Models	24 V LED Models
Polarity				

MECHANICAL DRAWING (RAISED BUTTON)

units: mm
 tolerance:
 $X \leq 5.0$: ± 0.2 mm
 $5.0 < X < 30.0$: ± 0.3 mm
 $X \geq 30.0$: ± 0.5 mm
 unless otherwise noted
 panel thickness: 6.0 mm max

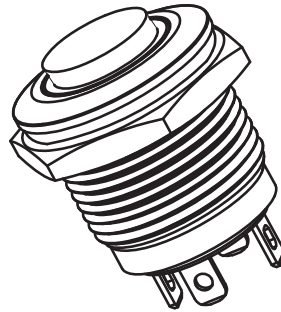

DESCRIPTION	MATERIAL	PLATING/COLOR
housing	stainless steel	---
actuator	stainless steel	---
switch terminals	brass	gold
LED terminals	brass	silver
nut	brass	nickel
base	PA66 (UL94HB)	white

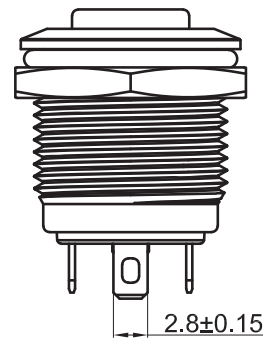
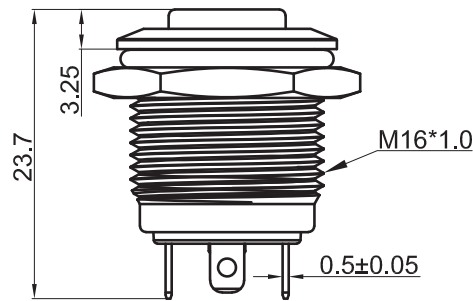
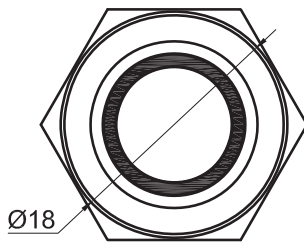

ACTUATOR POSITION (): MOMENTARY	
NORMAL	DOWN
OFF	[ON]
SCHEMATIC	

LED Terminal Pin (Silver plated)

Connector Pin (Gold plated)

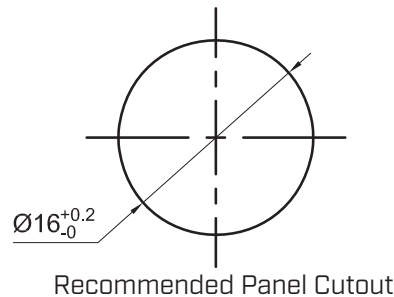
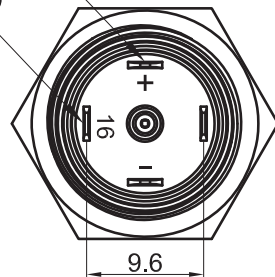

LED Table			
Model	Red-Green Model	2-12 V LED Models	24 V LED Models
Polarity			

REVISION HISTORY

rev.	description	date
1.0	initial release	04/07/2026

The revision history provided is for informational purposes only and is believed to be accurate.



Same Sky offers a one (1) year limited warranty. Complete warranty information is listed on our website.

Same Sky reserves the right to make changes to the product at any time without notice. Information provided by Same Sky is believed to be accurate and reliable. However, no responsibility is assumed by Same Sky for its use, nor for any infringements of patents or other rights of third parties which may result from its use.

Same Sky products are not authorized or warranted for use as critical components in equipment that requires an extremely high level of reliability. A critical component is any component of a life support device or system whose failure to perform can be reasonably expected to cause the failure of the life support device or system, or to affect its safety or effectiveness.

[sameskydevices.com](https://www.sameskydevices.com)