

SERIES: CP85H | DESCRIPTION: PELTIER MODULE

FEATURES

- arcTEC™ structure on select models
- enhanced reliability for high thermal cycling
- superior thermal performance
- silicon sealed
- wide ΔT_{max}
- low profile
- precise temperature control
- solid state construction

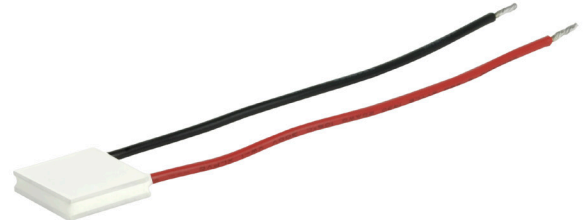

MODEL

	input voltage ¹	input current ²	internal resistance ³	output Qmax ⁴		output ΔT_{max} ⁵	
	max [Vdc]	max [A]	typ [$\Omega \pm 10\%$]	$T_h = 27^\circ\text{C}$ [W]	$T_h = 50^\circ\text{C}$ [W]	$T_h = 27^\circ\text{C}$ [°C]	$T_h = 50^\circ\text{C}$ [°C]
CP85134H	2.1	8.5	0.2	10.3	11.3	70	77
CP85153034H	4.2	8.5	0.4 ⁷	21	23	70	77
CP85234H	3.8	8.5	0.35	18.8	20.8	70	77
CP852040345H ⁶	7.6	8.5	0.75	38.2	42	70	77
CP85301534H	4.2	8.5	0.4 ⁷	21	23	70	77
CP853345H ⁶	8.8	8.5	0.85	43.1	48	70	77
CP8530345 ⁶	11.8	8.5	1.15	57.7	63.4	70	77
CP854020345H ⁶	7.6	8.5	0.75	38.2	42	70	77
CP854345H ⁶	15.7	8.5	1.5	77.1	85	70	77

- Notes:
1. Maximum voltage at ΔT_{max} and $T_h = 27^\circ\text{C}$
 2. Maximum current to achieve ΔT_{max}
 3. Measured by AC 4-terminal method at 25°C
 4. Maximum heat absorbed at cold side occurs at I_{max} , V_{max} , and $\Delta T = 0^\circ\text{C}$
 5. Maximum temperature difference occurs at I_{max} , V_{max} , and $Q = 0\text{W}$ (ΔT_{max} measured in a vacuum at 1.3 Pa)
 6. Designed with arcTEC™ structure.
 7. Internal resistance tolerance is $\pm 12.5\%$

SPECIFICATIONS

parameter	conditions/description	min	typ	max	units
solder melting temperature	connection between thermoelectric pairs	235			°C
assembly compression				1	MPa
RoHS	yes				

MECHANICAL DRAWING

units: mm

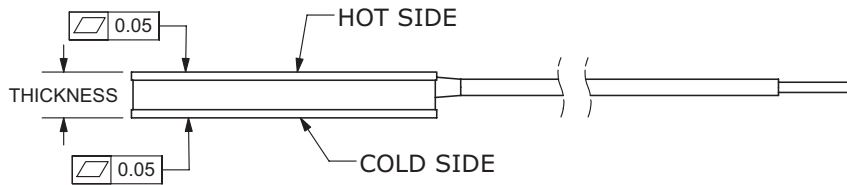

	MATERIAL	PLATING
ceramic plate	96% AL ₂ O ₃	
wire leads	20 AWG	tin
sealer	silicon rubber 703 RTV (between cold and hot side plates)	
joint cover	silicon rubber 703 RTV	
marking	P/N & S/N printed on cold side surface	

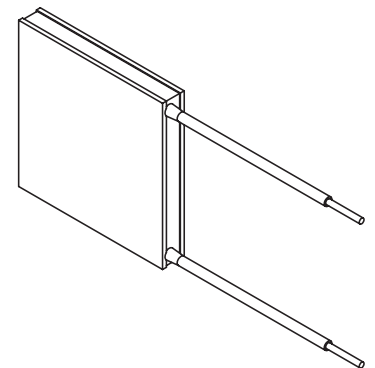
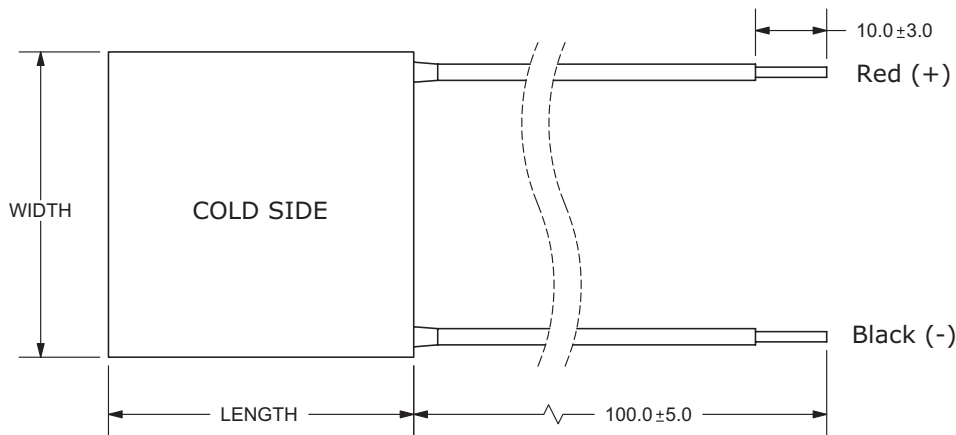

MODEL NO.	LENGTH [mm]	WIDTH [mm]	THICKNESS [mm]
CP85134H	15 ±0.3	15 ±0.3	3.4 ±0.025
CP85153034H	15 ±0.3	30 ±0.3	3.4 ±0.025
CP85234H	20 ±0.3	20 ±0.3	3.4 ±0.025
CP852040345H	20 ±0.3	40 ±0.3	3.45 ±0.025
CP85301534H	30 ±0.3	15 ±0.3	3.4 ±0.025
CP853345H	30 ±0.3	30 ±0.3	3.45 ±0.025
CP8530345	30 ±0.3	30 ±0.3	3.45 ±0.025
CP854020345H	40 ±0.3	20 ±0.3	3.45 ±0.025
CP854345H	40 ±0.3	40 ±0.3	3.45 ±0.025

CP85134H PERFORMANCE (Th=27°C)

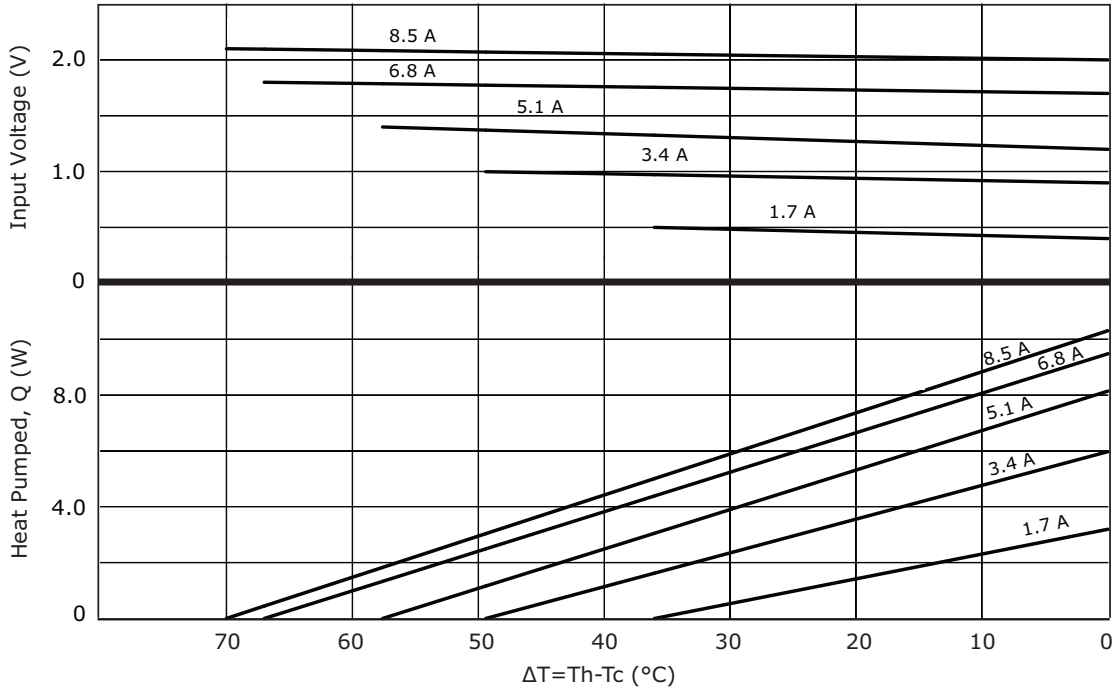

CP85134H PERFORMANCE (Th=50°C)

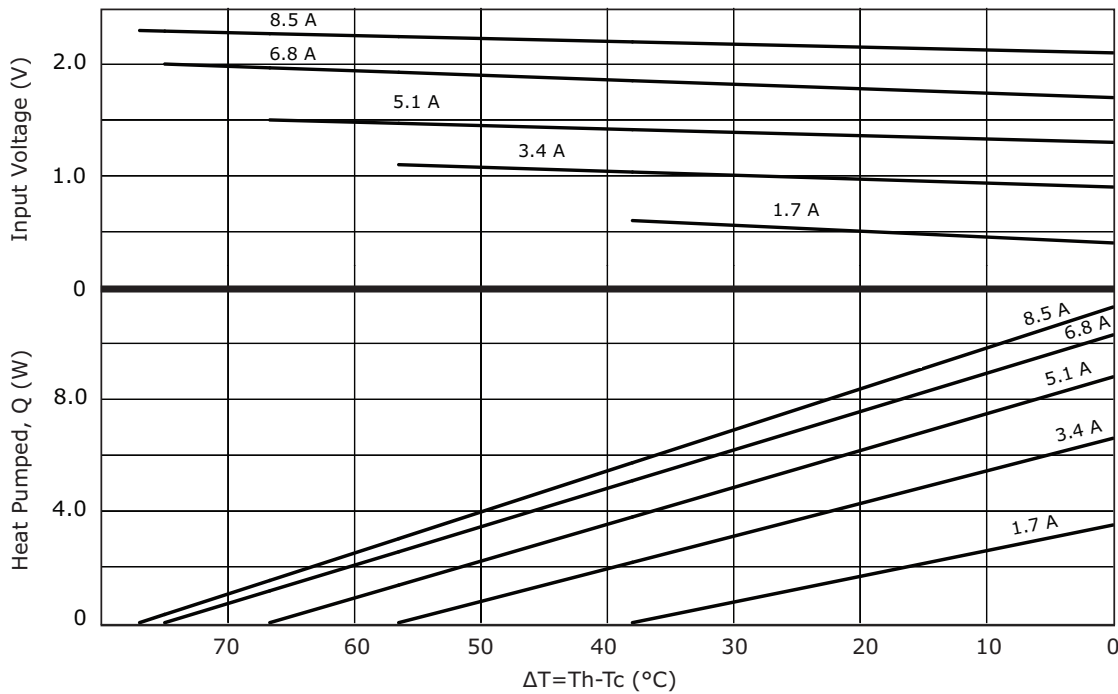

CP85153034H PERFORMANCE (Th=27°C)

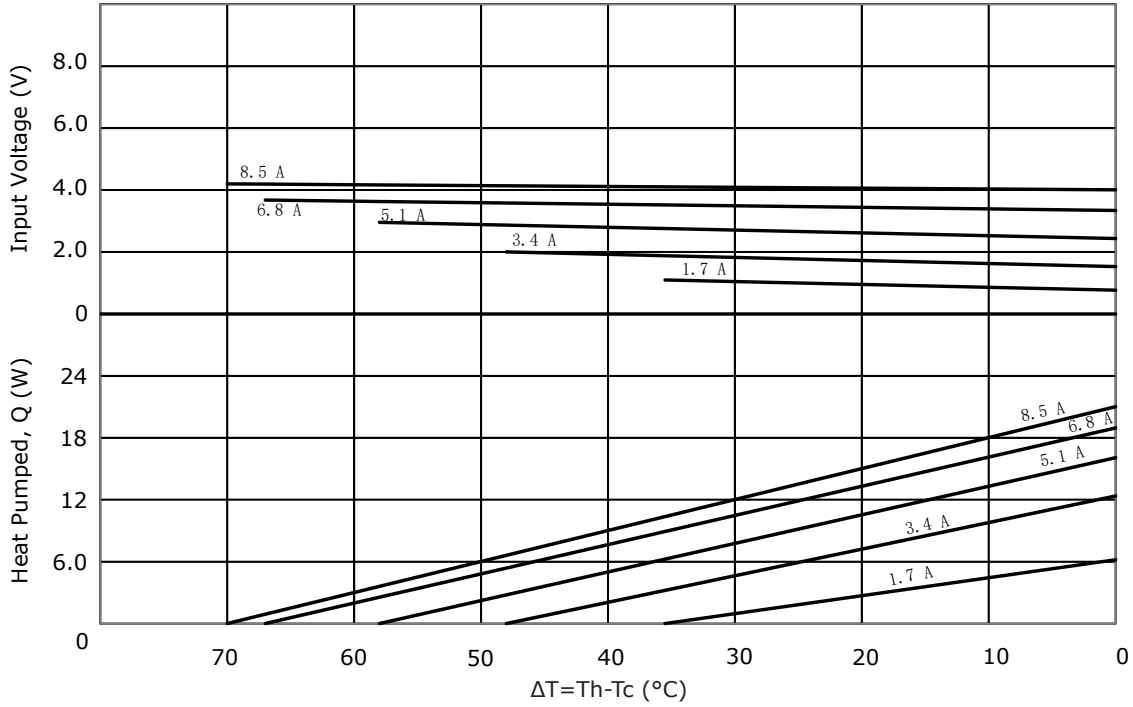

CP85153034H PERFORMANCE (Th=50°C)

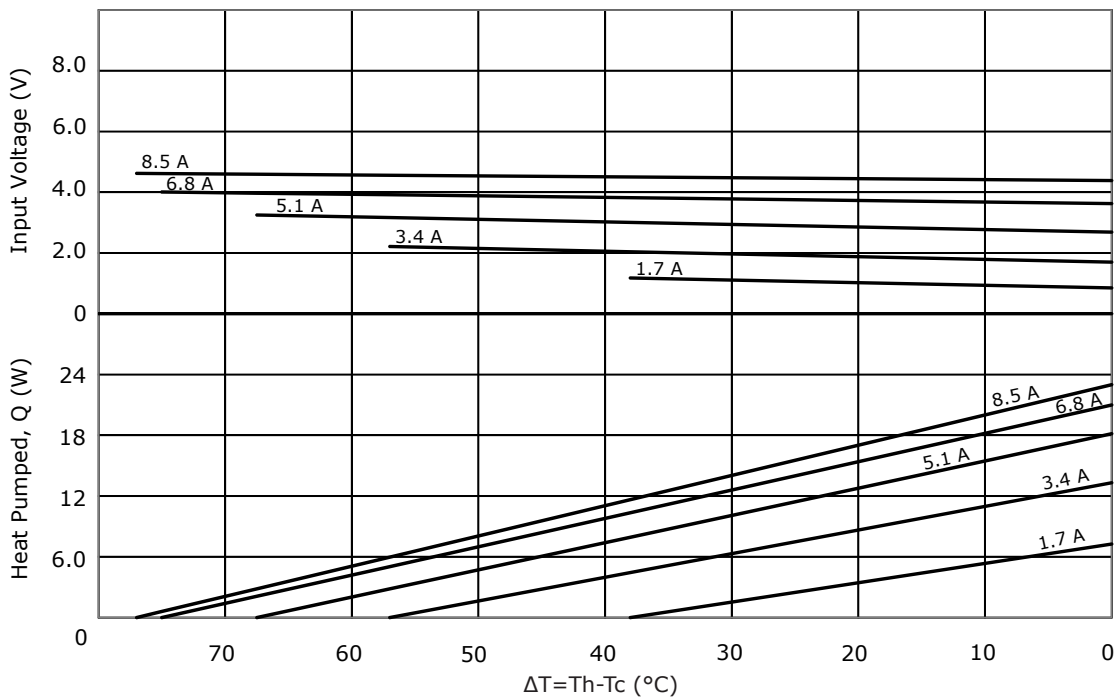

CP85234H PERFORMANCE (Th=27°C)

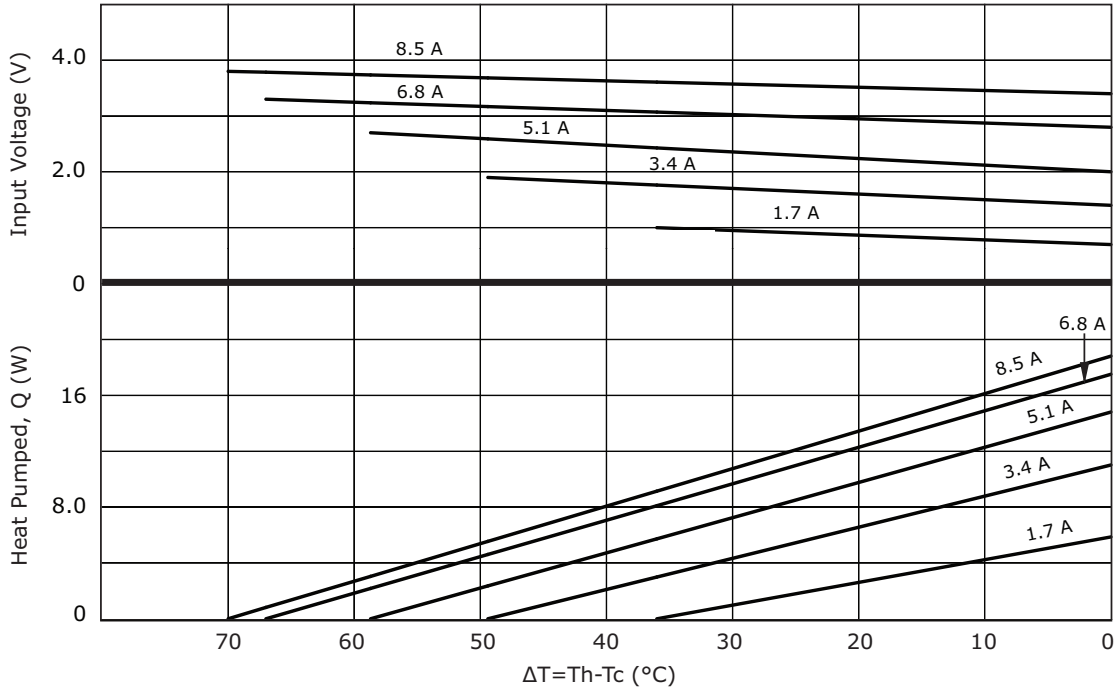

CP85234H PERFORMANCE (Th=50°C)

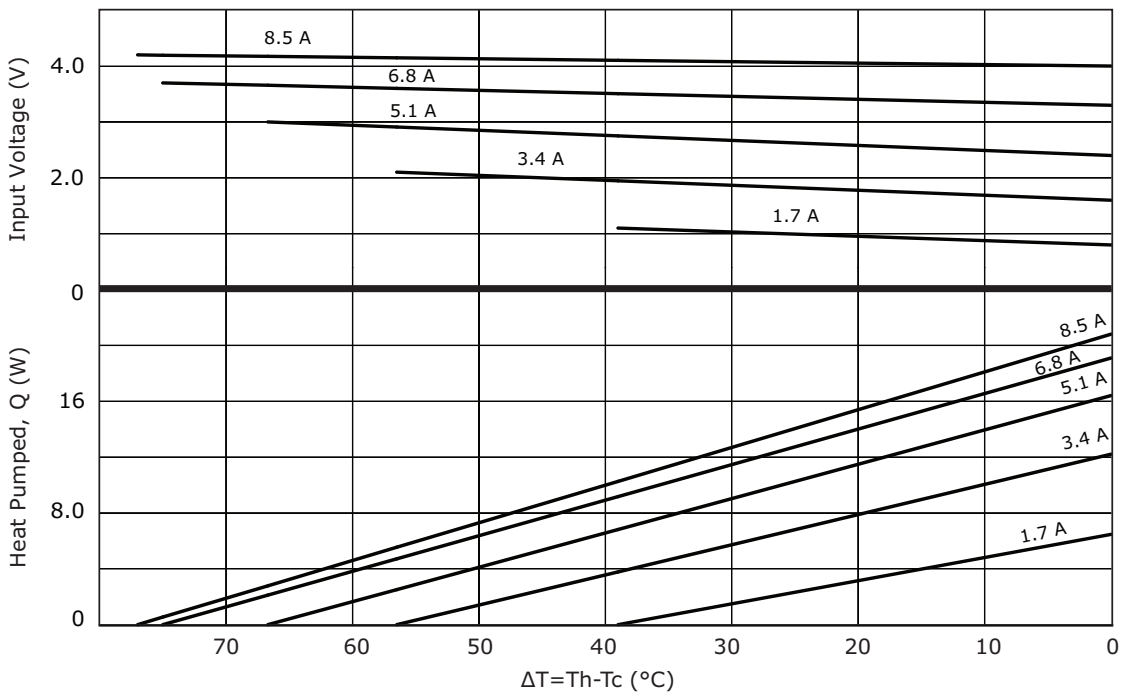

CP852040345H PERFORMANCE (Th=27°C)

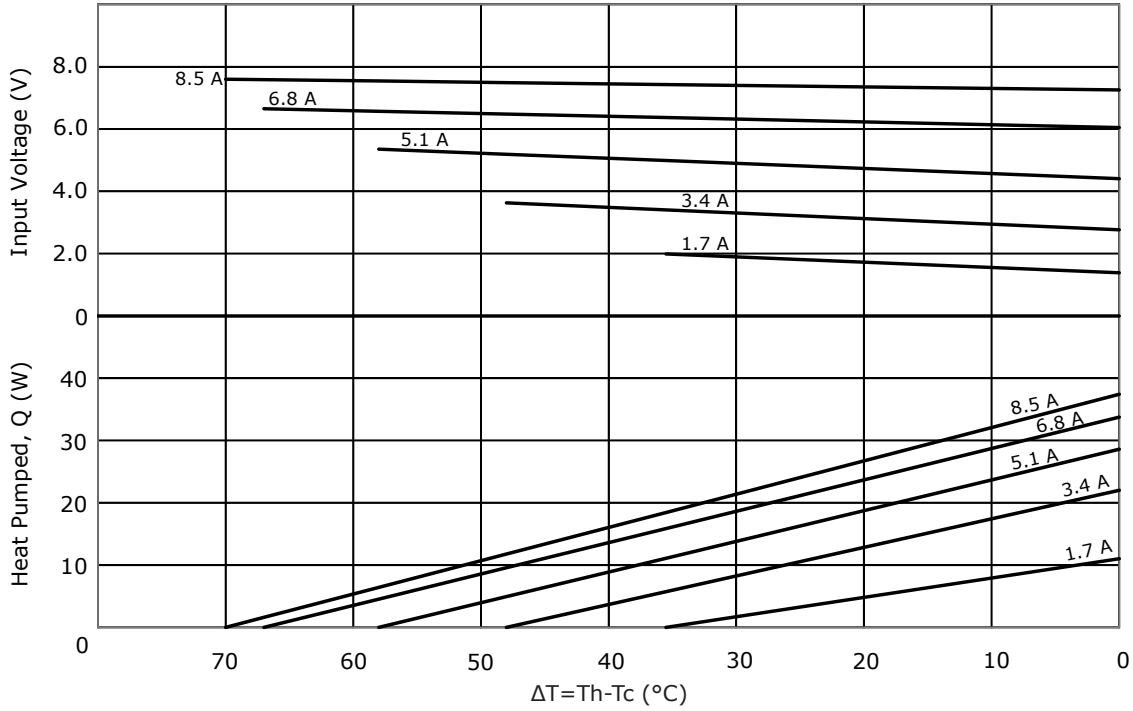

CP852040345H PERFORMANCE (Th=50°C)

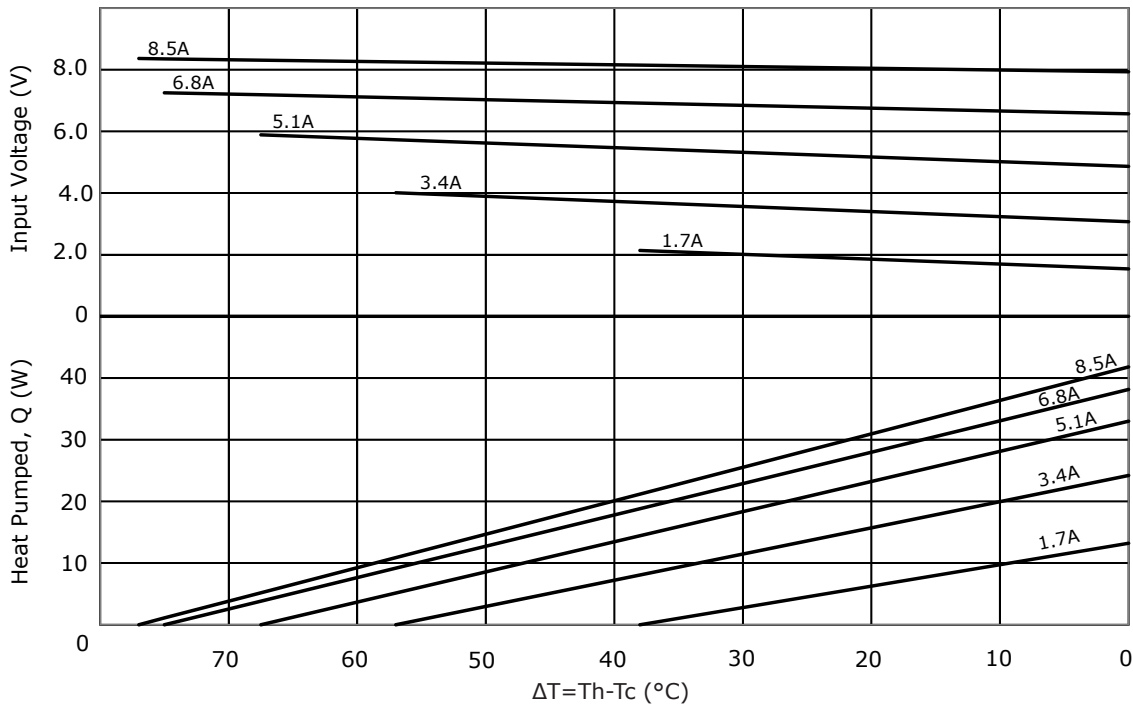

CP85301534H PERFORMANCE (Th=27°C)

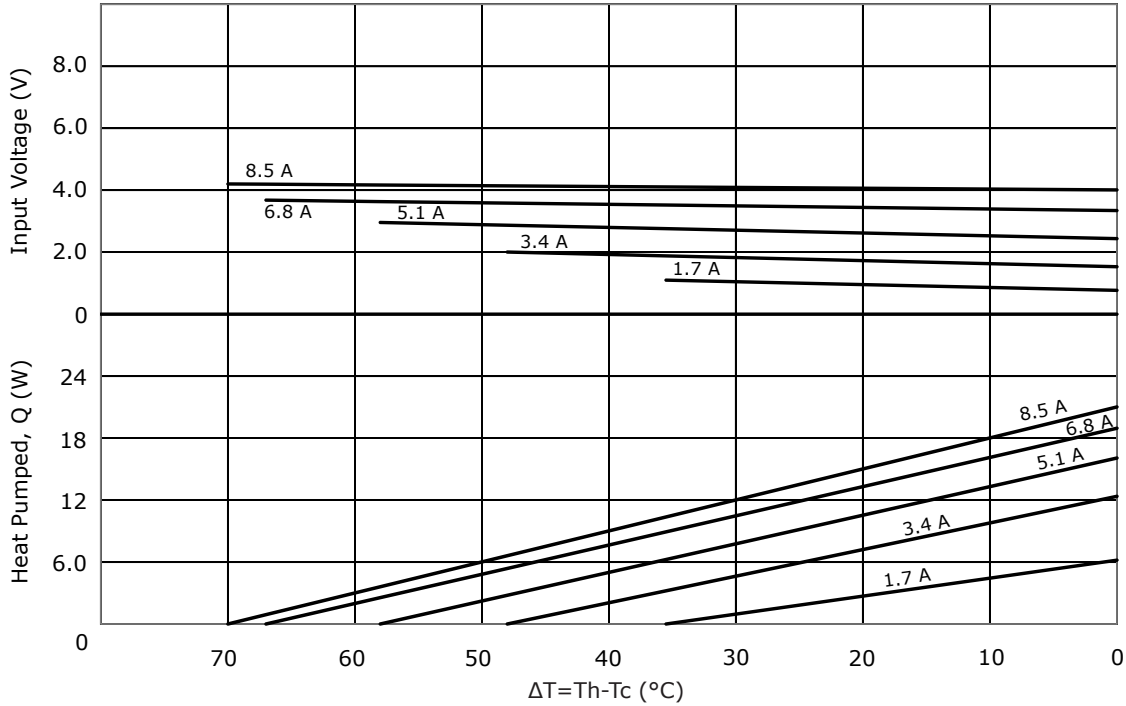

CP85301534H PERFORMANCE (Th=50°C)

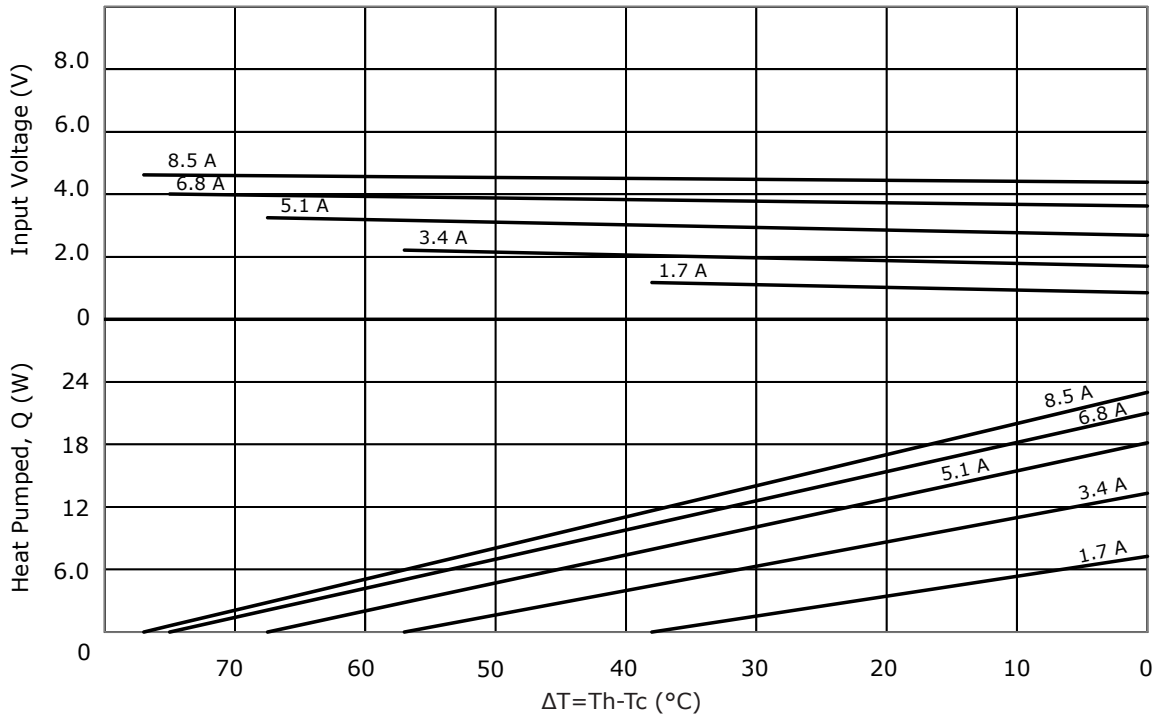

CP853345H PERFORMANCE (Th=27°C)

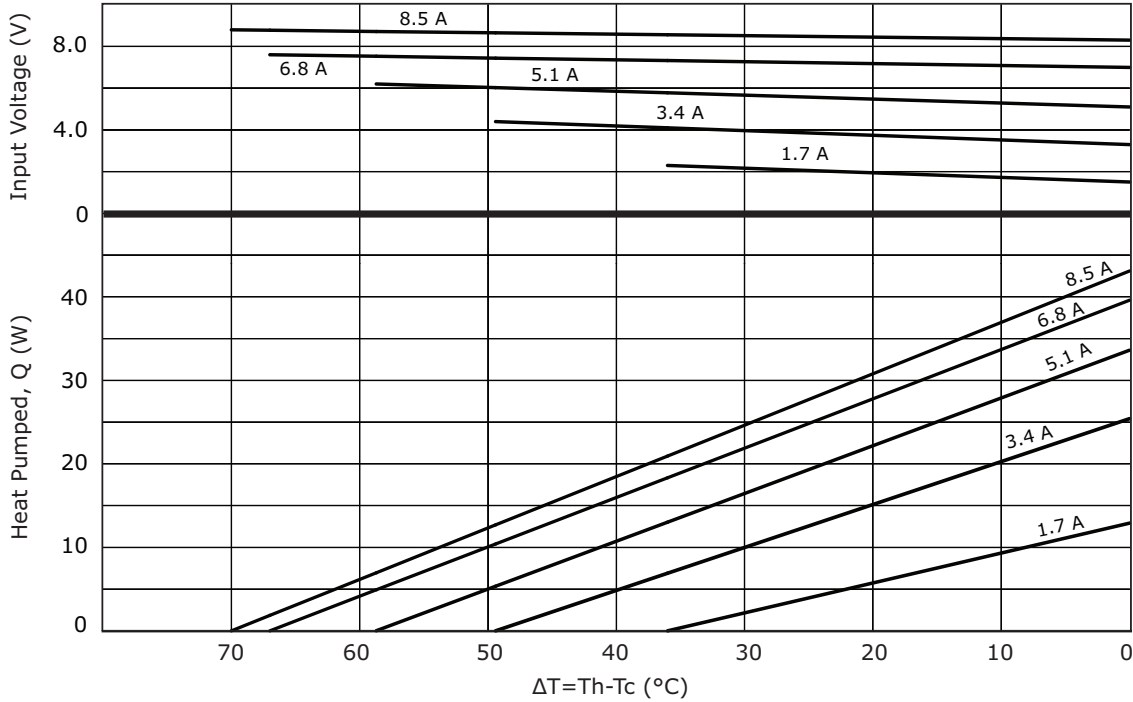

CP853345H PERFORMANCE (Th=50°C)

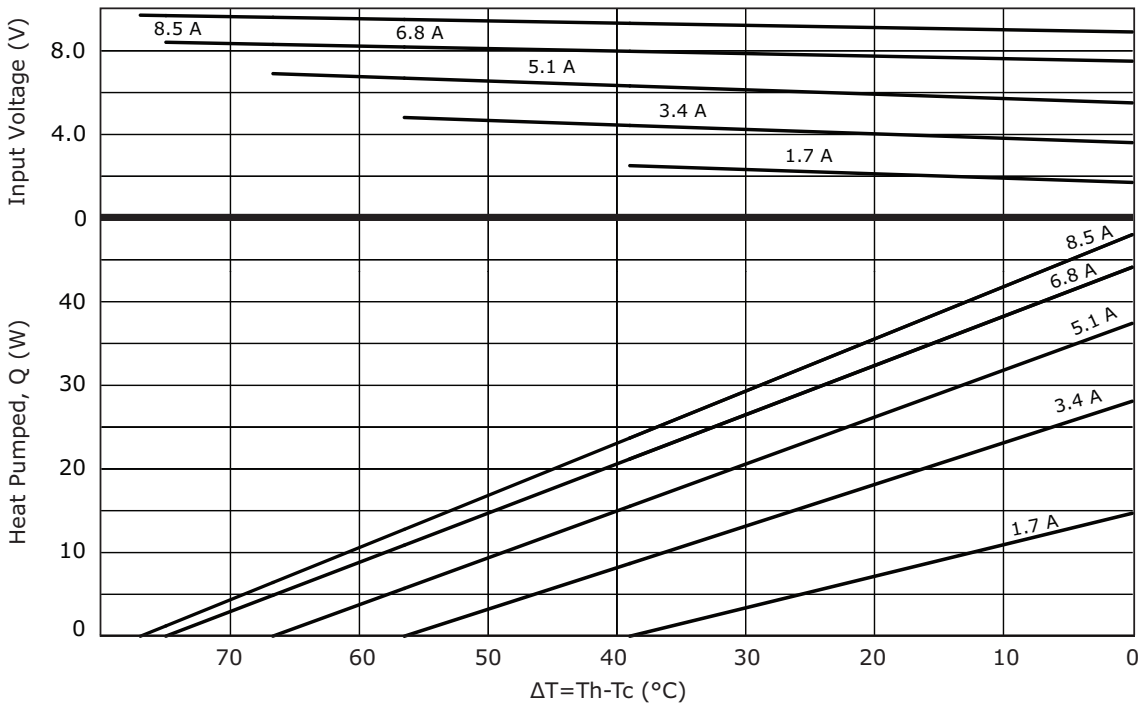

CP8530345 PERFORMANCE (Th=27°C)

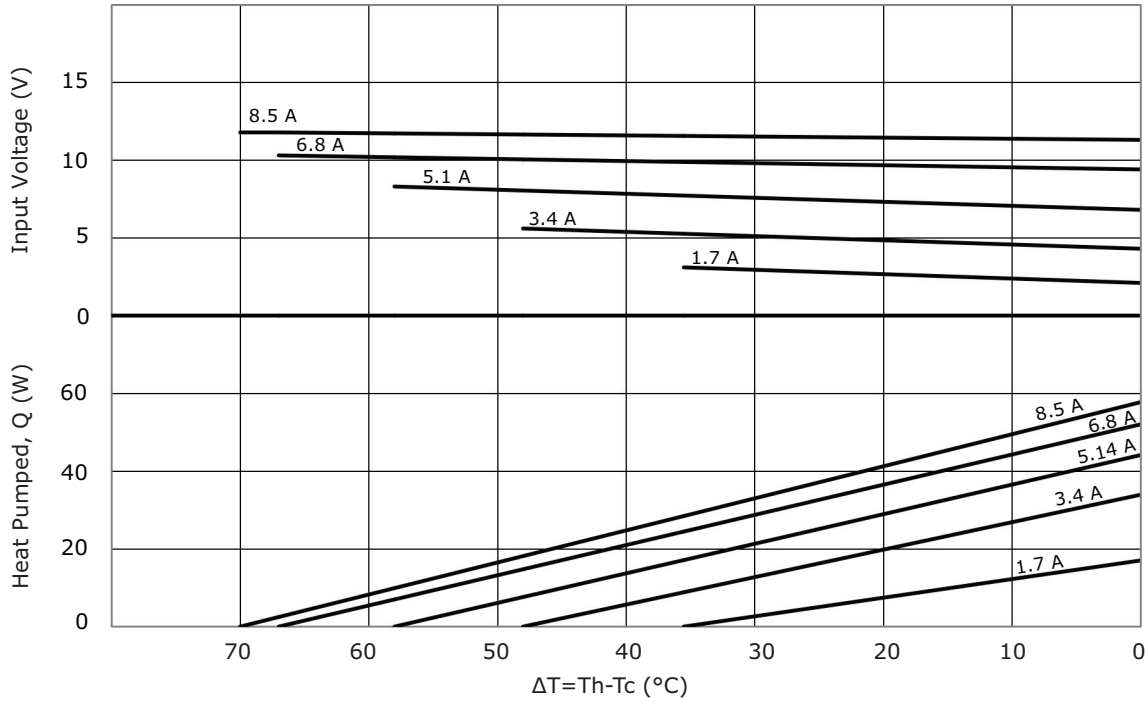

CP8530345 PERFORMANCE (Th=50°C)

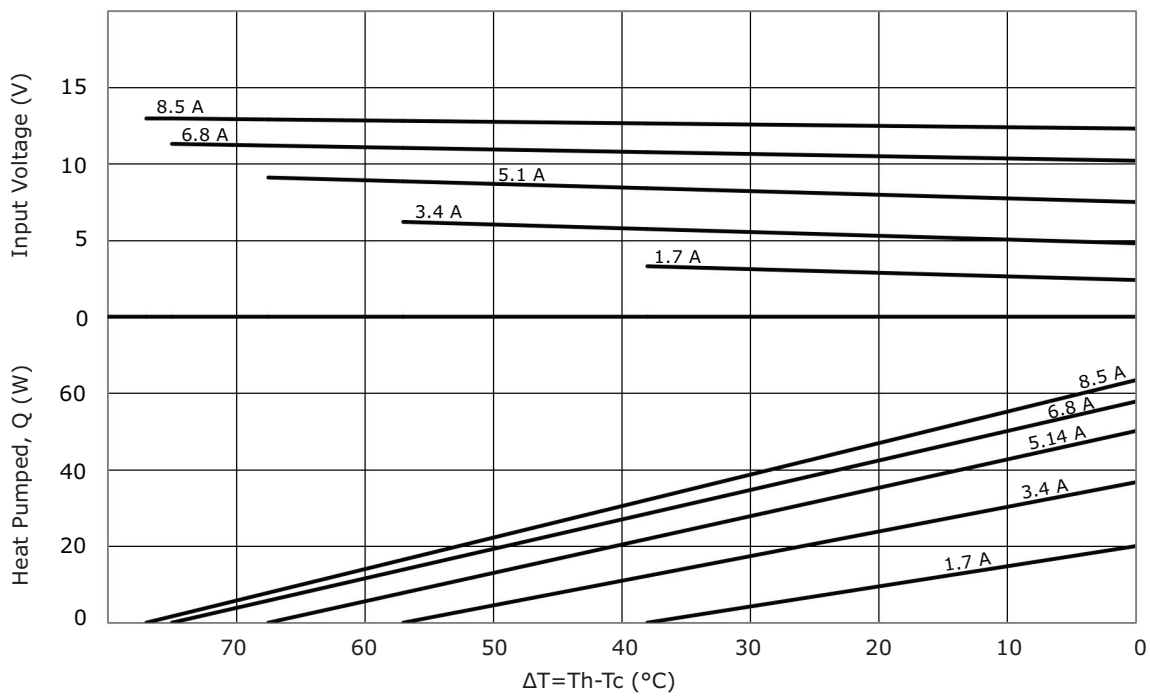

CP854020345H PERFORMANCE (Th=27°C)

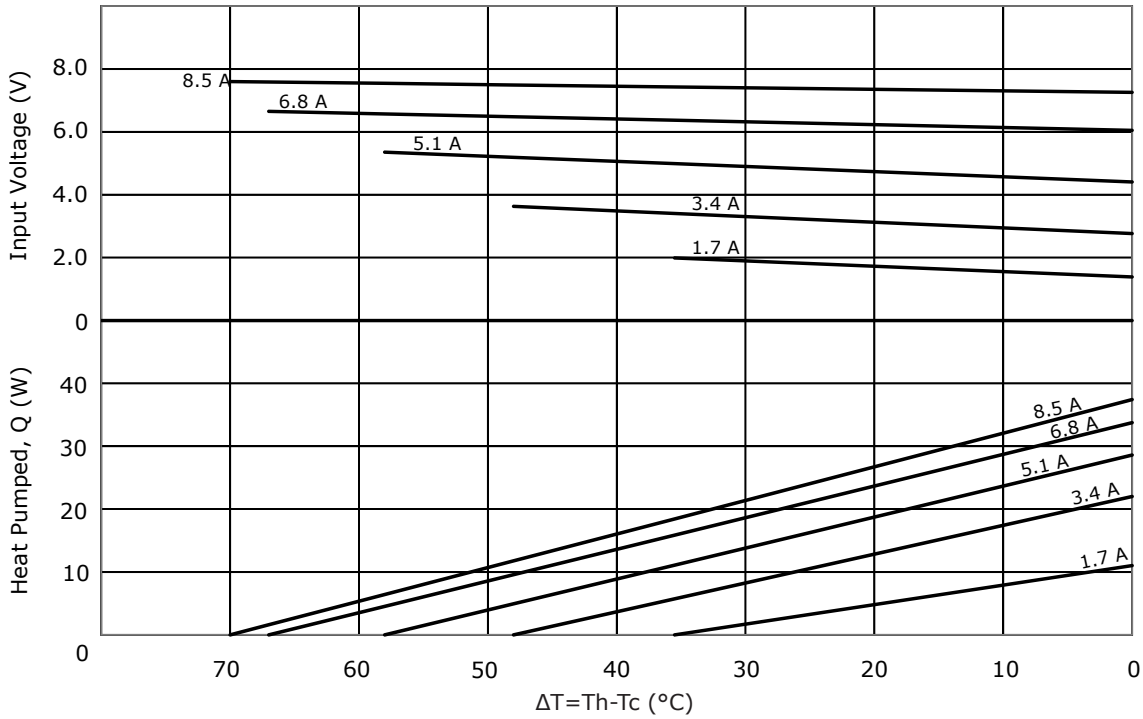

CP854020345H PERFORMANCE (Th=50°C)

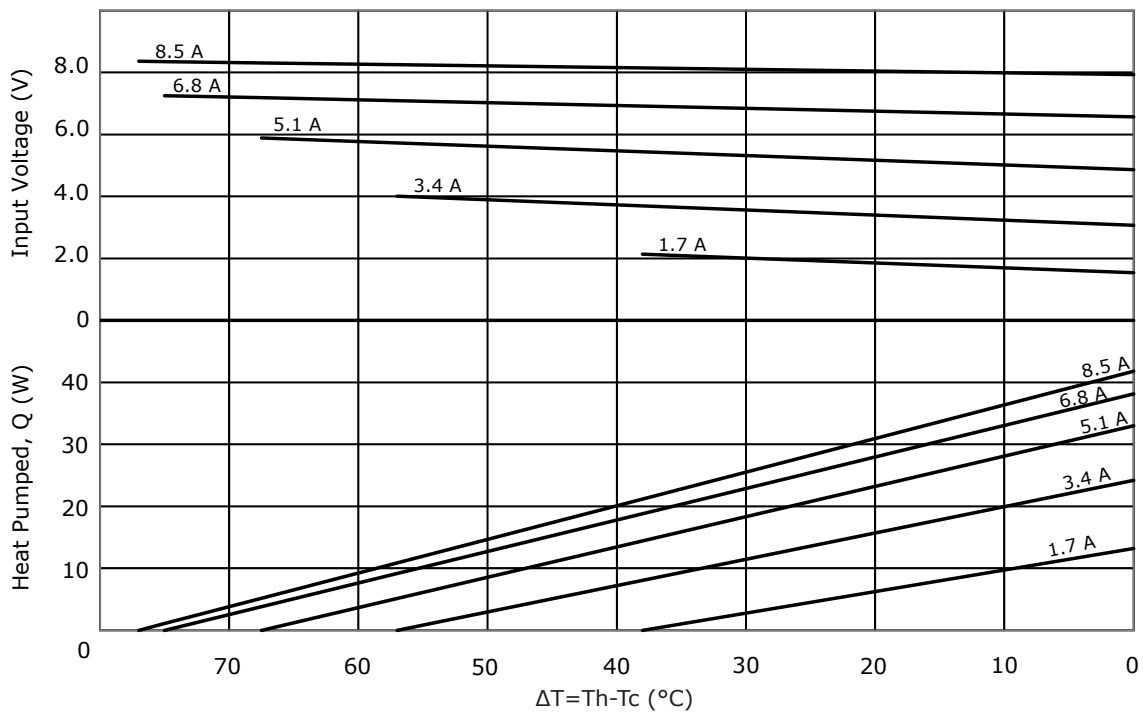

CP854345H PERFORMANCE (Th=27°C)

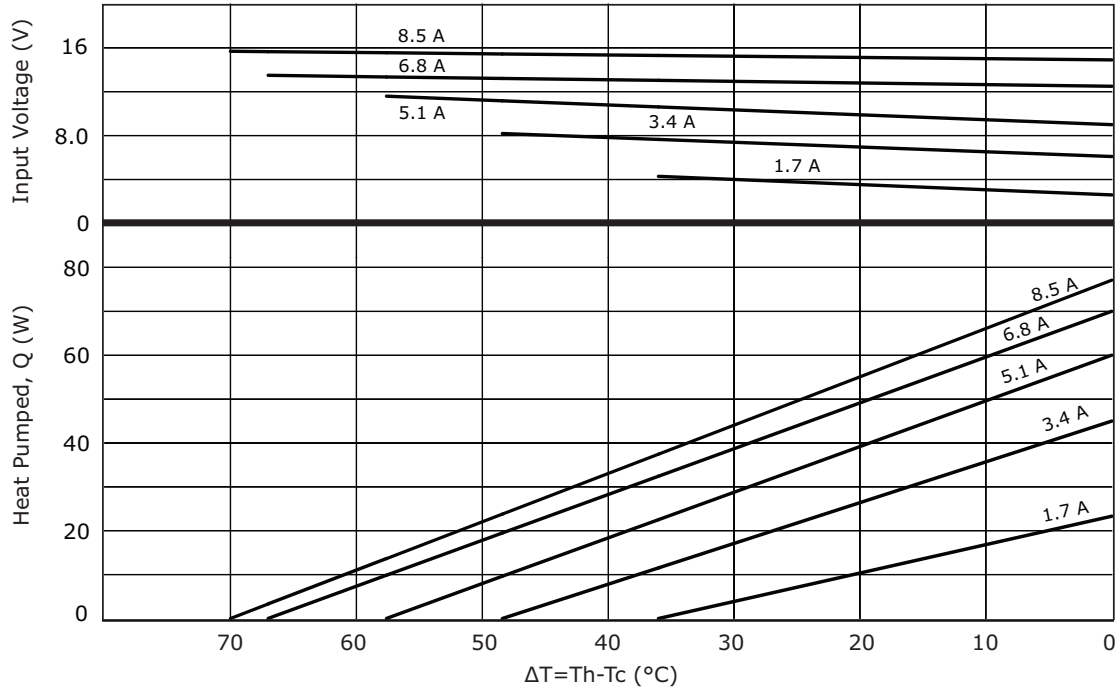

CP854345H PERFORMANCE (Th=50°C)

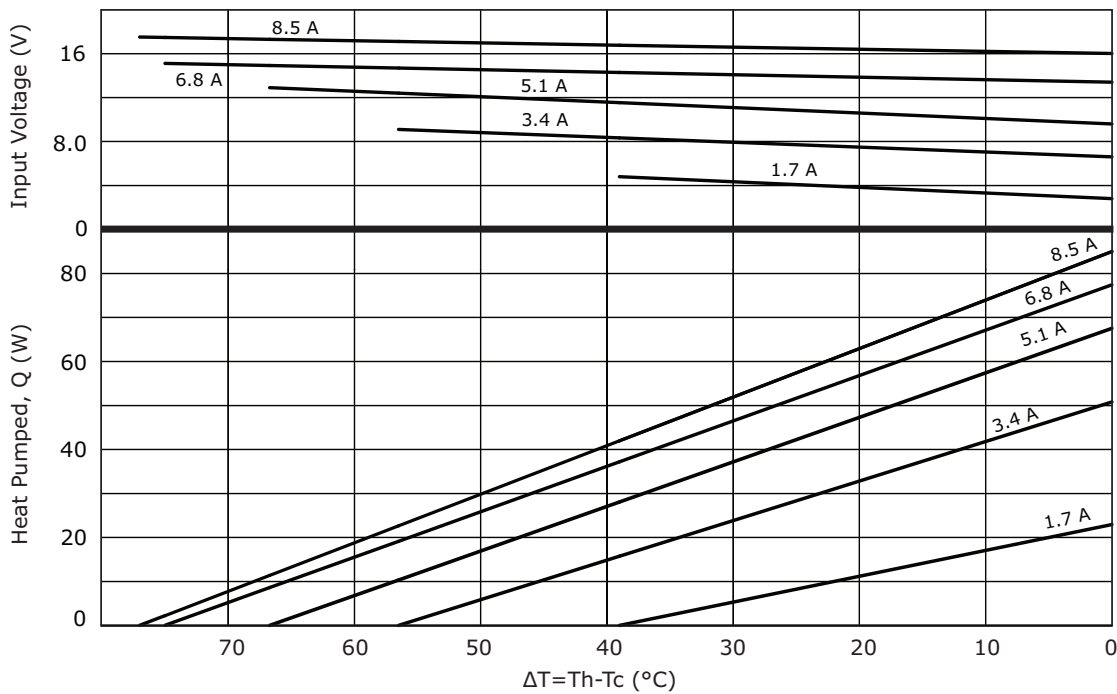

REVISION HISTORY

rev.	description	date
1.0	initial release	09/08/2016
1.01	updated datasheet	09/25/2017
1.02	added new models	05/21/2018
1.03	added model CP8530345, brand update	10/18/2019
1.04	logo, datasheet style update	08/05/2022
1.05	CUI Devices rebranded to Same Sky	09/12/2024

The revision history provided is for informational purposes only and is believed to be accurate.



Same Sky offers a one (1) year limited warranty. Complete warranty information is listed on our website.

Same Sky reserves the right to make changes to the product at any time without notice. Information provided by Same Sky is believed to be accurate and reliable. However, no responsibility is assumed by Same Sky for its use, nor for any infringements of patents or other rights of third parties which may result from its use.

Same Sky products are not authorized or warranted for use as critical components in equipment that requires an extremely high level of reliability. A critical component is any component of a life support device or system whose failure to perform can be reasonably expected to cause the failure of the life support device or system, or to affect its safety or effectiveness.

[sameskydevices.com](https://www.sameskydevices.com)